

Nano CNC for High-Speed, High-Accuracy Machining

FANUC

Series 30i/31i/32i/35i -MODEL B



Nano CNC for High-Speed, High-Accuracy Machining

Wide Application Range

Select the CNC model best suited for the application.

FANUC Series 30i-MODEL B

Max. number of paths : 10 - 15 paths

Max. total number of controlled axes :

96 axes (72 feed axes, 24 spindles) / 10 paths

72 axes (56 feed axes, 16 spindles) / 15 paths

Max. number of simultaneous controlled axes : 24 axes

The 30i-B is an advanced CNC for multi-axis, multi-path machine tools. Due to the high number of controlled axes and paths, various machining processes can be executed at the same time. The 5-axis machining function also allows machining of complex shapes. It has the flexibility to control various types of machine tools.

FANUC Series 31i-MODEL B

Max. number of paths : 6 paths

Max. total number of controlled axes : 34 axes (26 feed axes, 8 spindles)

Max. number of simultaneous controlled axes : 4 axes

With the world's highest level of performance, This is the core FANUC CNC model. With abundant functions and advanced control technology, it is ideal for high performance lathes and machining centers.

FANUC Series 31i-MODEL B5

Max. number of paths : 6 paths

Max. total number of controlled axes : 34 axes (26 feed axes, 8 spindles)

Max. number of simultaneous controlled axes : 5 axes

The 31i-B5 has 5-axis simultaneous machining functions and can machine complex shapes at high-speed with high accuracy and high quality. It is best suited for leading edge 5-axis machining centers.

FANUC Series 32i-MODEL B

Max. number of paths : 2 paths

Max. total number of controlled axes : 20 axes (12 feed axes, 8 spindles)

Max. number of simultaneous controlled axes : 4 axes

This is a standard model with versatile CNC functions and is designed for the control of standard lathes and machining centers.

FANUC Series 35i-MODEL B

Max. number of paths : 4 paths

Max. total number of controlled axes : 20 axes (16 feed axes, 4 spindles)

Max. number of simultaneous controlled axes : 4 axes

The 35i-B CNC is for transfer lines. It has powerful PMC functions and basic CNC functions. The 35i-B can execute simple machining at high speed.



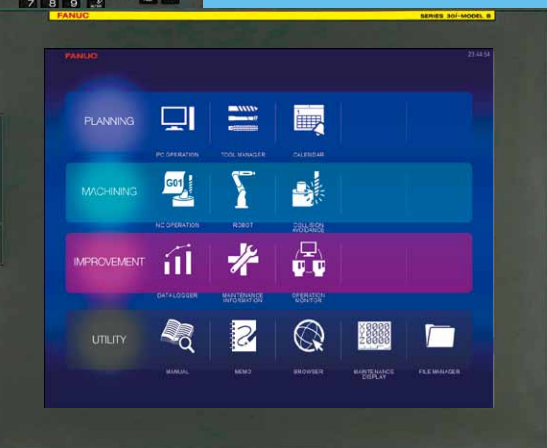
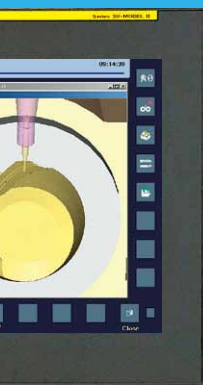

State-of-the-Art Hardware

Ultra-thin, high-speed and high reliability is achieved by state-of-the-art hardware, including ultra high-speed processors, high-speed CNC internal bus and optical fiber cables used for high-speed data transfer.

High-Speed, High Precision and High Quality Machining

High-speed, high accuracy machining is realized by using not only a CNC that controls the machine with nanometer resolution but also servos and drive systems that accurately position the machine.

High-Speed, High Precision and Smooth simultaneous 5-Axis Machining

These models are available for 5-axis machines with various configurations. A function which enables smooth, high-speed and high precision machining and easy programming of machining complex parts with tilted plane and a function of facilitating setup are included.

Consistent support at shop floor, FANUC *i*HMI

FANUC *i*HMI provides unique user interface for all machines, and support all jobs at shop floor consistently. It enables easy understanding by the screen contents using graphical expression like intuitive icons and animations.

Various Network Functions

A management system with personal computers and a robot connected via Ethernet can be constructed easily. Various types of field networks are also supported.

High Reliability and Easy Maintainability

Highly reliable hardware allows stable operation in a harsh factory environment. Various types of enhanced diagnosis functions improve maintainability so that the cause of trouble can be identified quickly.

Easily Incorporated into Machine Tools

The CNC is mounted directly to the LCD panel in one unit which saves space in the power magnetics cabinet. The use of ultra high-speed serial communications reduces wiring. Powerful PMC allows flexibility of machine design, and built-in safety function helps MTB to conform safety regulation easily.

PC function with Windows® OS

FANUC PANEL *i*H Pro is an enhanced combination of a CNC and PC with a original high-speed interface. The PC function with a compact operating system for embedded use is also available.

State-of-the-Art High-Speed, High-Reliability Hardware

Ultra-Compact, Reduced wiring, High-Reliability

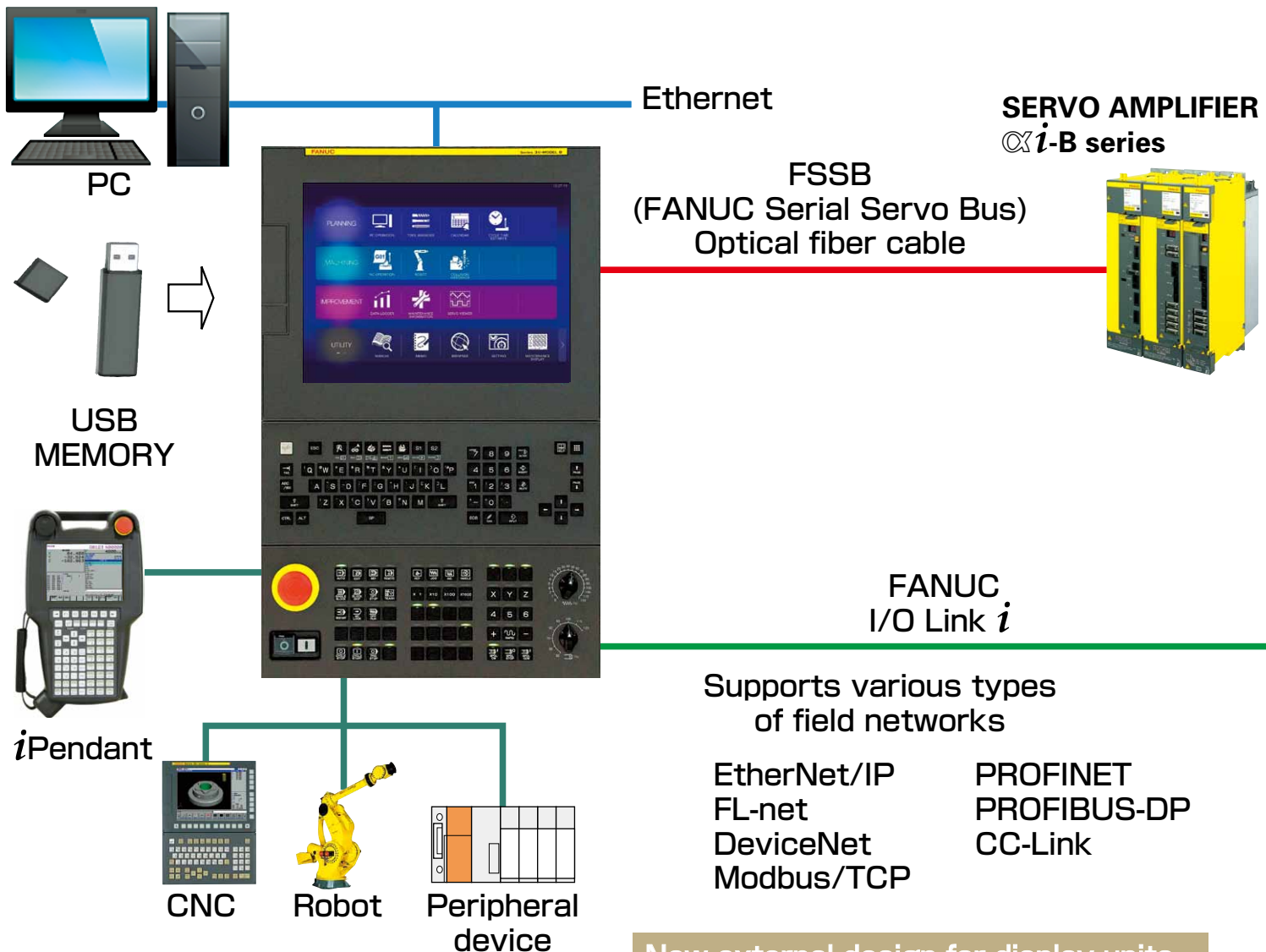

Enhanced basic performance

Leading-edge hardware has enhanced the basic performance of the CNC, servos and the PMC to support advanced CNC functionality such as 5-axis machining, multi-axis multi-path control.

Thin and compact

The LCD-mounted type CNC with all the functionality implemented behind the display greatly reduces CNC mounting space on the machine. This contributes to downsizing. Intelligent communication functions are also embedded in the ultra-thin control unit of 60mm in depth, which helps design a compact operator's panel. 19", 15", 10.4", and 8.4" color LCDs are available as a CNC display. The stand-alone type CNC, a control unit with a separate display, is also available. You can select a CNC suitable to your machine structure.

New external design for display units

The external design for FANUC PANEL *iH/iH Pro* has been renewed to a flat structure to cover the surface with one film to improve the cutting fluid resistance. In addition, the MDI structure has been improved to improve operability and enable key input operations with few mistakes.

Leading-edge servo control with fast FSSB and high-speed DSP

CNC and amplifiers are connected with FSSB (FANUC Serial Servo Bus) using an optical fiber cable. Leading-edge DSPs and newly-designed FSSB offer advanced servo control such as multi axis control and fast current control. In addition, spindle amplifiers can be now connected to FSSB.

iPendant

iPendant is a portable operating unit. It is possible to watch the CNC screen and operate the machines at a distant point from the main operator's panel. Moreover, touch panel and the manual pulse generator can be selected as an option.

SERVO AMPLIFIER

*β*SVSP-B series



AC SPINDLE MOTOR

*α*i-B series,
*β*i-B series

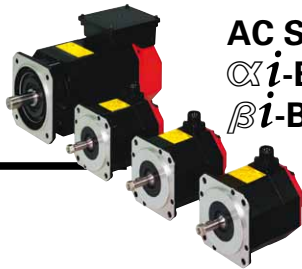

AC SERVO MOTOR

*α*i-B series,
*β*i-B series



I/O Unit



I/O module for
connection panel

FANUC I/O Link *i*

FANUC I/O Link *i* is a serial I/O interface between the PMC and various I/O units. The number of DI/DO points per channel is 2048/2048, doubled from conventional FANUC I/O Link.

FANUC I/O Link *i* helps with quick recovery from trouble by making it easy to pinpoint the faulty part using various error detection capabilities such as bitwise DO ground fault detection and I/O power supply failure detection, etc. FANUC I/O Link *i* realizes Dual Check Safety with a single cable although conventional systems require two cables.

Reduced wiring

Faster FSSB and FANUC I/O Link *i* realize further reduction of wiring and lower wiring cost.

USB memory interface

A USB port is added on the front of the CNC display unit. USB memory is easily obtainable in the market and can be used to input and output various data in the CNC, so usability is enhanced.

FANUC AC SERVO MOTOR

*α*i-B, *β*i-B series

High performance AC SERVO MOTOR for feed axis of machine tools

Smooth rotation and compact size

Quick acceleration

Excellent waterproofing

Compact size and high resolution PULSECODER

Bayonet type power connector

Reduced Backlash Brake

Line-up with both 200V input and 400V input.

FANUC AC SPINDLE MOTOR

*α*i-B, *β*i-B series

High performance AC SPINDLE MOTOR for spindles of machine tools

High power and high torque with compact size.

High efficiency and low heat generation by SPINDLE HRV Control.

Hollow shaft models which enable center-through-coolant available.

Line-up with both 200V input and 400V input.

S6 rated output available with the same rated output of S3

The balance correction is possible at the rear of the motor after the motor is coupled to the spindle.

FANUC SERVO AMPLIFIER

*α*i-B, *β*iSVSP-B series

Compact and energy-saving SERVO AMPLIFIER that contributes to downsizing of the electrical cabinet

Achieves high-speed, high-precision and high-quality machining through the high-power and high-precision current control

Preventive maintenance possible by detecting insulation deterioration of motors under cutting fluid environment
Quick replaceable fan motor from the front side of the amplifier

Cause of alarms can find quickly by trouble diagnosis function.

A wide line-up of multi-axis amplifiers and all-in-one amplifiers integrating servo and spindle

Machine protection at power failure is enabled by adding modules according to the purpose

Energy saving by utilizing the latest low loss power device

Line-up with both 200V input and 400V input.

Enhanced network functions

Enhanced network functions support various types of field networks. Embedded Ethernet of 100Mbps is also supported as a standard function.

High reliability realized by ECC

Error correcting code (ECC) is a leading-edge high reliability technology. Should an error occur during data transfer, it can be detected and corrected.

Although ECC is already being applied to various portions of the CNC, the range of applications are further expanded and the whole CNC system is protected. ECC and original low power technologies contribute to high reliability.

High-Speed, Fine-Surface Machining

Machining Performance

Fine Surface Technology

Fine Surface Technology is a collective term for CNC and servo control technologies that achieve Fine-Surface machining. Fine Surface Technology allows for the interpolation of high precision machining program output from CAD or CAM, high-speed execution of small segment programs, the generation of a smooth tool path and accurate command tracing.

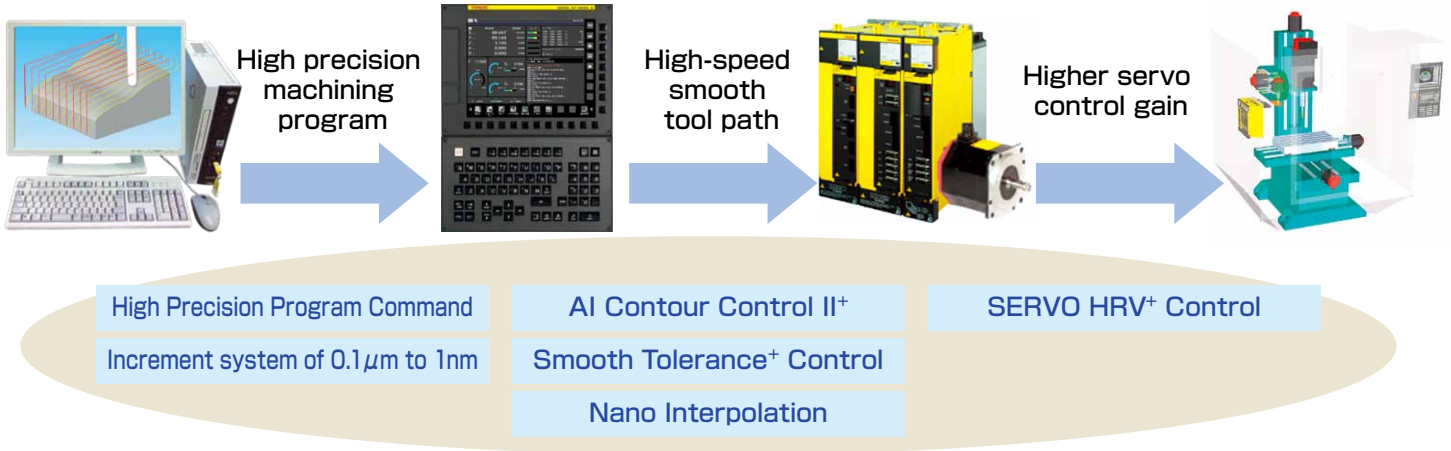

High precision program command

Supports high precision machining program output from CAD or CAM

High precision programs can be interpolated without changing the increment system of the CNC. This eliminates errors caused by rounding in the program command unit.

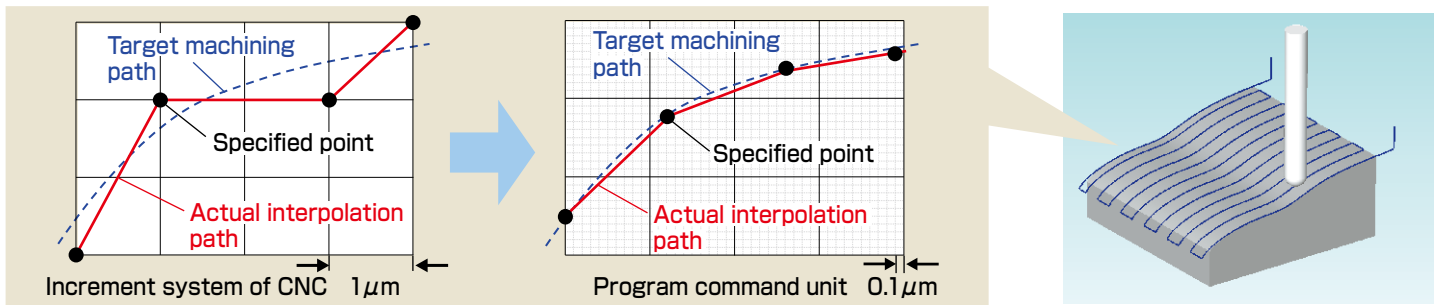

AI Contour Control II⁺

Optimum the feedrate and acceleration control by reading blocks in advance

During the complex machining of aircraft or automobile parts, molds or other items that are specified as continuous small blocks, it is possible to determine the specified shape by reading program commands in advance, realizing control with a feedrate and acceleration optimal to the performance of the machine.

By analysing the machining program at a high speed, even small segment programs, which are required for Fine-Surface machining, can be executed at a high speed.



Smooth Tolerance⁺ Control

Smoothing continuous small blocks to realize Fine-Surface machining

The machining path specified in continuous small blocks, like the one for mold machining, is smoothed out within the specified allowance error tolerance. The smooth machining path reduces mechanical shock and improves the quality of the machined surface.

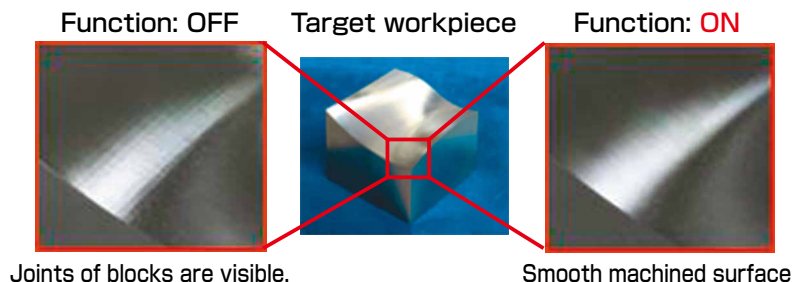

Joints of blocks are visible.

Smooth machined surface

Smart Machine Control

Optimizing control in real time

Smart machine control is function group which realizes high-speed, high-precision, and Fine-Surface machining by optimizing its control in real time according to changes of machine conditions such as load, temperature, and position.

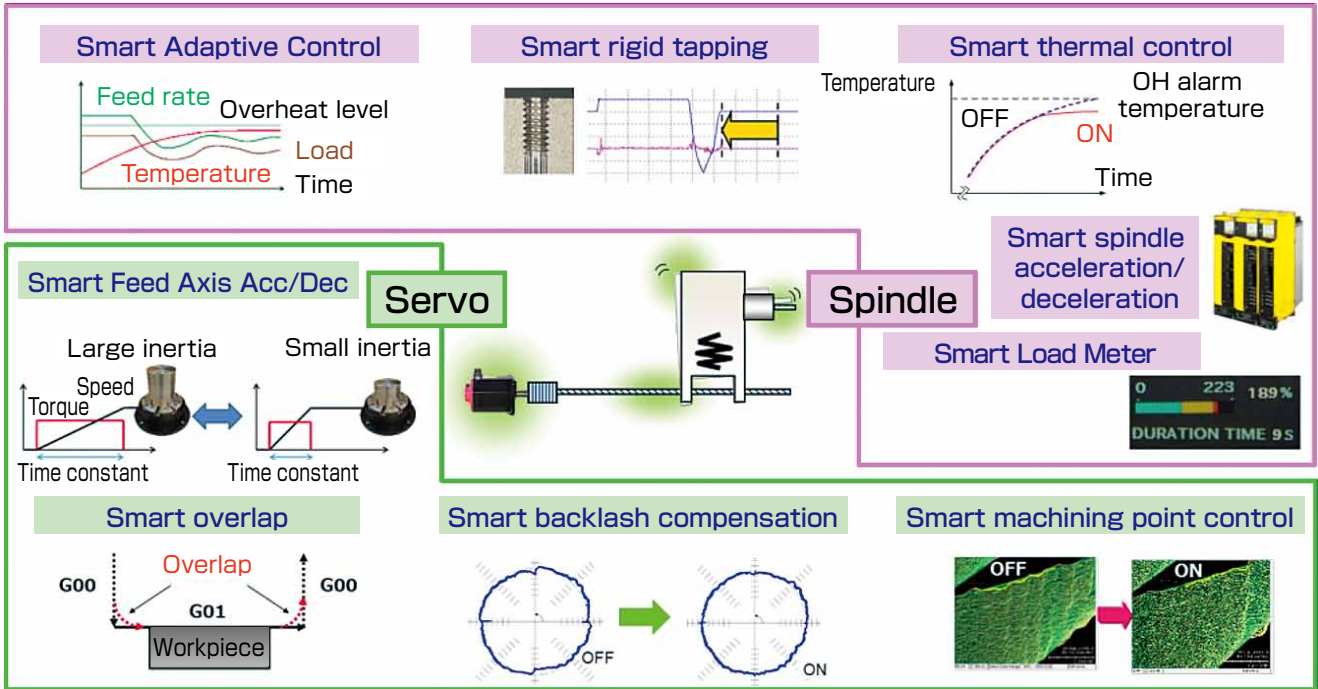

SERVO HRV (High Response Vector) Control

High-speed and high precision servo control

By combining hardware technology and software technology such as the latest servo control HRV+, high-speed and high precision control with nano-meter level is ensured. Mechanical resonance can be suppressed by automatic following HRV filter even though its frequency changes.

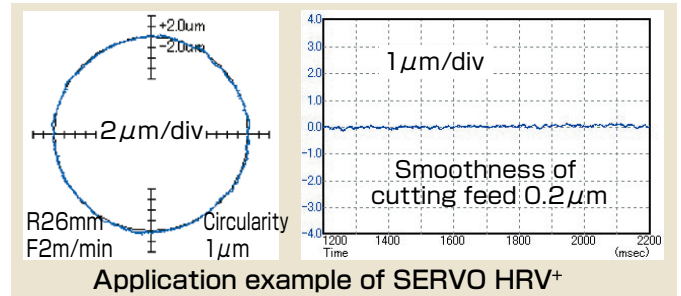

SPINDLE HRV (High Response Vector) Control

Spindle control realizing fast response and high precision

- Achieving high gain control and low heat generation at high-speed rotation by faster sampling time of the current control loop
- Optimum orientation using the optimum deceleration level according to the inertia of works or tools
- Supporting Nano Interpolation in position control enabling Nano CNC system for spindle as well as feed axis
- Smart rigid tapping function using maximum Acc/Dec power of spindle motor and achieving the fastest tapping with no tuning

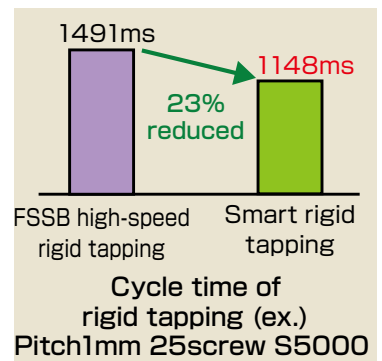
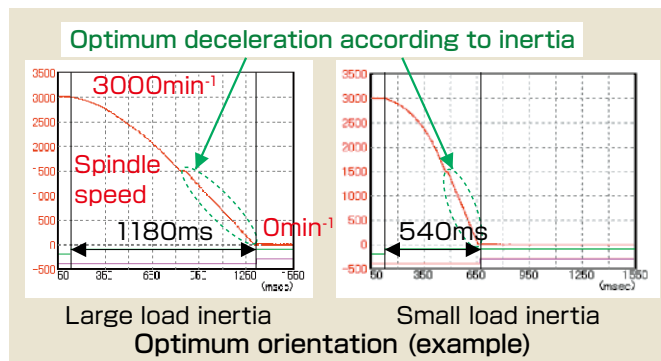
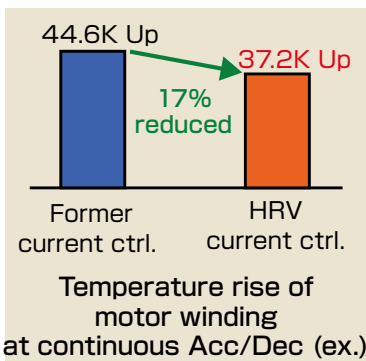

5-axis Machining Functions Achieve a Smooth, High-speed,

Provided for a smooth, high-speed, and high-precision 5-axis machining **30i-B, 31i-B5 Only**

FANUC's 5-axis machining functions achieve a smooth machining not only in a high-precision mold machining but also in a high-speed part machining.

- Smooth** In the case of not only tool center point machining but also side cut machining, smooth 5-axis machining is achieved by automatic command compensation of the machining programs. It results in the reduction of machining time due to eliminating needless accelerations/decelerations.
- High-speed** High-speed 5-axis machining is achieved by optimizing algorithms of CNC software.
- High-precision** High-precision 5-axis machining is achieved by applying the high precision machining technology (AI contour control) that FANUC has refined for years.
- Easy to use** Convenient functions for use on the shop floor are supplied.
- Cooperation with CAM** The latest 5-axis machining functions are supported by major CAM makers

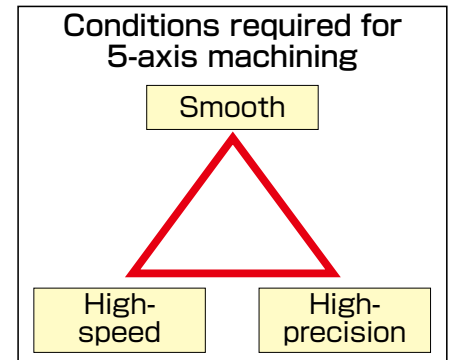

High-speed Smooth TCP that achieves smooth high-speed and high-quality 5-axis machining **30i-B, 31i-B, 31i-B5 Only**

High-speed and smooth simultaneous 5-axis machining

Smooth TCP makes the machining movement smooth by compensating tool direction to decrease the unevenness, and improves the quality of the machined surface and reduce machining time.

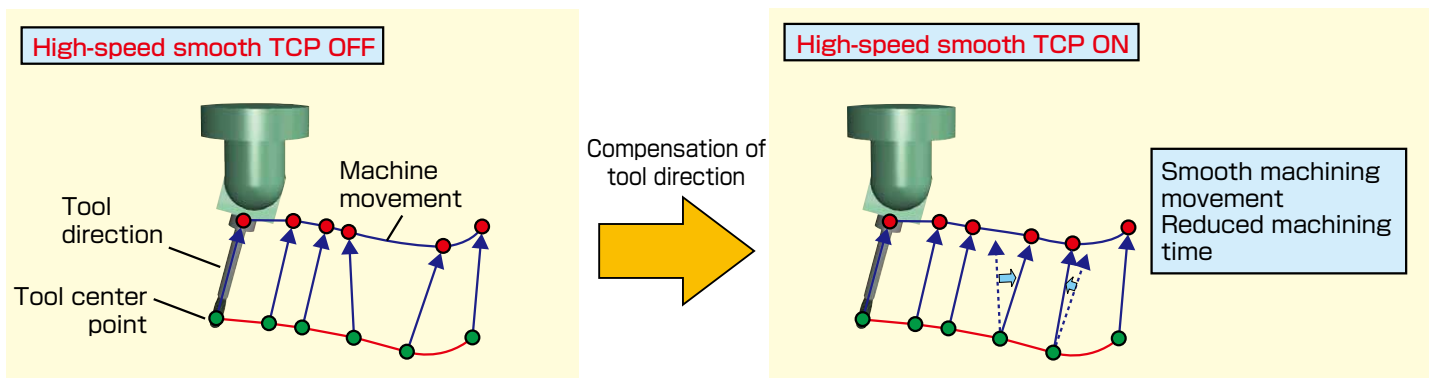

High-precision simultaneous 5-axis machining using Smooth tolerance+ control

High-speed smooth TCP are used together with smooth tolerance+ control, then the quality of the surface is improved greatly by smoothing tool center point path even if NC program consists of continuous small points.

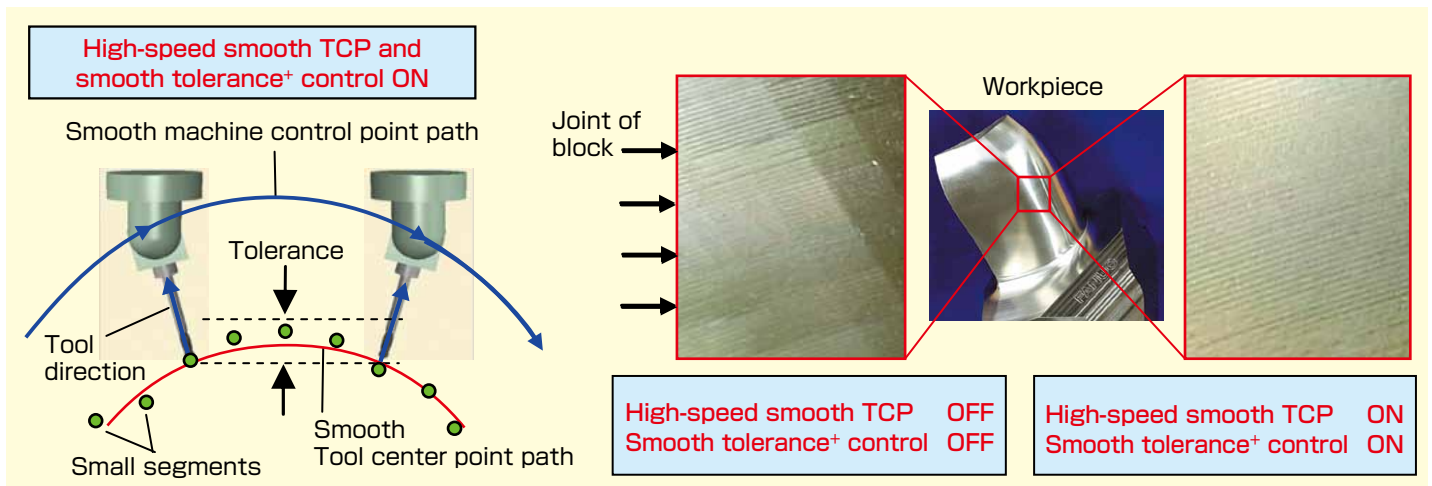

Tilted working plane indexing

30i-B, 31i-B, 31i-B5, 32i-B Only

For machining a hole, pocket, or another figure on a tilted plane on a workpiece, specifying the working plane with plane (X, Y) makes programming very easy. The tilted working plane indexing enables this specification and also positions the tool automatically so that the tool becomes perpendicular to the tilted working plane without specifying the tool direction.

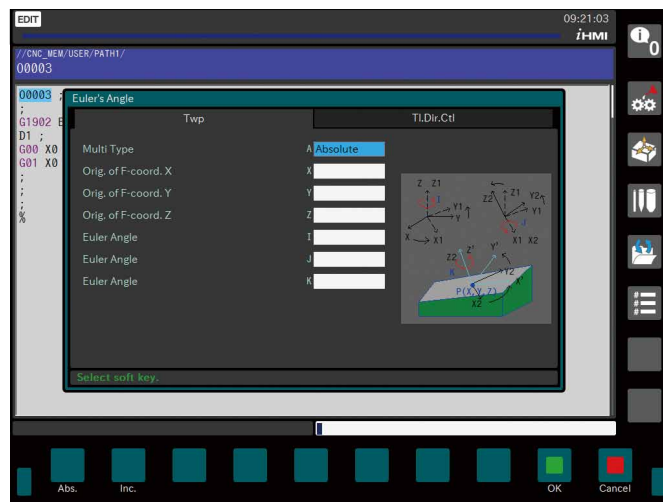
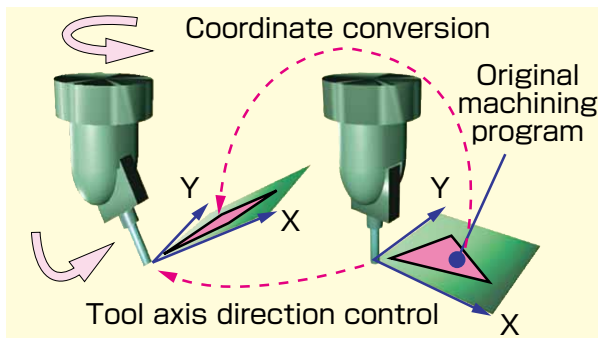

Guidance screen

5-axis Machine Tool Error and Adjustment

30i-B, 31i-B, 31i-B5, 32i-B Only

Using the 5-axis machine tool's rotary axis position measurement cycle, you can easily measure the center position of the rotary axis. Measurement results will be automatically applied to the machine configuration parameters. It reduces the time taken for adjustment and enables high-precision 5-axis machining. All 5-axis machine configurations, including table rotation, tool rotation, and composite types are supported.

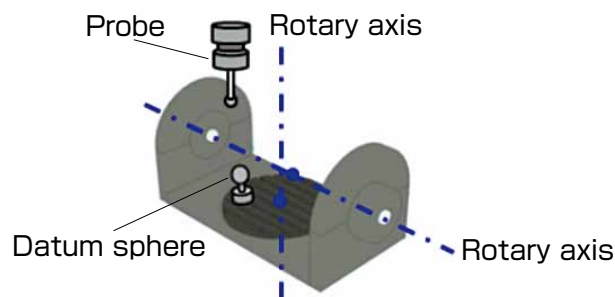

FANUC SERVO GUIDE 3-D View Function

Servo tuning tool, FANUC SERVO GUIDE supports 3-D View Function.

"3-D tool path" and "Time based waveform of each servo axis" are displayed in the same window. Enhanced display or color-coded display of path deviation makes it easy to find a point to be tuned. FANUC SERVO GUIDE is useful servo tuning tool for 5-axis machining, which saves time for tuning parameters and precision evaluation.

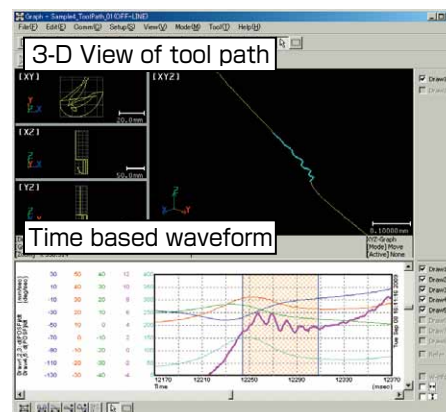

Tool path with time based waveform

Package for 5-axis machining and tilted working plane indexing

30i-B, 31i-B, 31i-B5 Only

High-speed smooth TCP which achieves high-speed, high-precision and smooth simultaneous 5-axis machining and Tilted working plane indexing which makes programming easy, these functions which are necessary for 5-axis machining are packaged.

Cooperation with CAM

With the cooperation of major CAM makers(*), the NC programs can be made using the latest 5-axis machining functions.

(*) C&G System, CNC software, Dassault Systems, DELCAM, DP Technology, Gibbs and Associates, OPEN MIND, Sescor KK, Tebis AG, Vero International (Alphabetical order)

Flexible Support of Various Mechanical Configurations Ease of Use

Expanded multi-axis and multi-path functions

30i-B, 31i-B, 31i-B5, 32i-B Only

Multiple functions for multi-axis and multi-path control

- A single CNC can achieve complex control of a multi-path lathe with many turrets, compound machine tool with a milling head, or automatic lathe requiring many axes and command systems.
- This CNC provide many functions required for multi-path control, such as synchronous/ composite control, superimposed control, flexible axis assignment, waiting function, and interference check.
- A combination of high-speed, high precision control technology that FANUC has cultivated for years and multi-axis multi-path control technology further promotes improvements in precision and efficiency of lathes and automatic lathes.

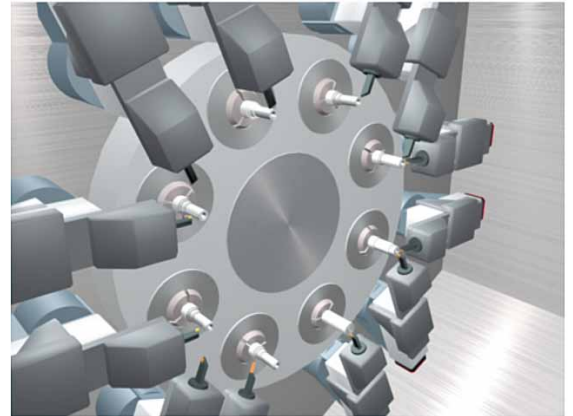

Rotary index machine

Multi-path program management function

30i-B, 31i-B, 31i-B5, 32i-B Only

Program management function is suitable for machining by multi-path programs.

- All part programs for machining can be created and selected by one operation easily.
- These programs can be displayed and edited on one screen simultaneously (maximum 3 programs).
- These multi-path programs for one machining can be input or output to as one file.

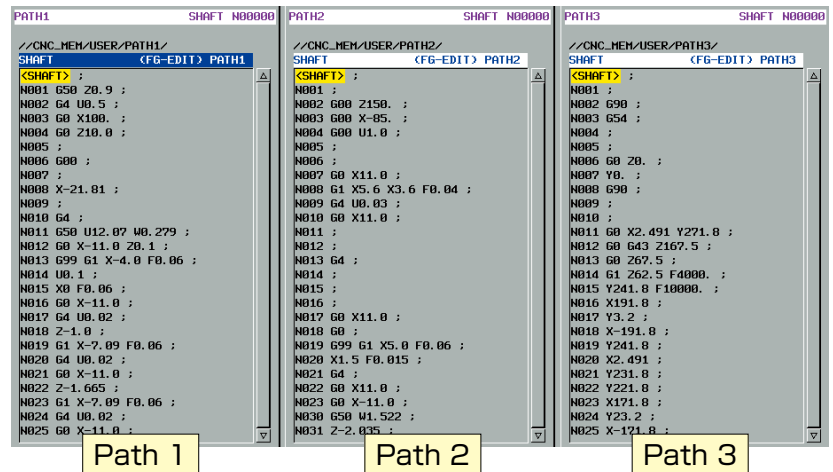

Editing all programs on one screen

Laser Control Function

Machining Performance

Laser control function transforms lathes and machining centers into laser multifunction machines

30i-B, 31i-B, 31i-B5, 32i-B Only

Adds laser machining functionality to lathes and machining centers to create laser multifunction machines

- The laser control function adds laser machining functionality to lathes and machining centers to create laser multifunction machines. Combined machining contributes to improved productivity.
- A variety of laser machining functions with proven results for the likes of sheet metal processing can be added.
 - Laser output command
 - Cutting condition setting function
 - Cap control for laser cutting, etc.
- High-speed laser control synchronized with the controlled axis can be easily added to machine tools, making it possible to support micromachining, additive manufacturing, etc.



Micromachining

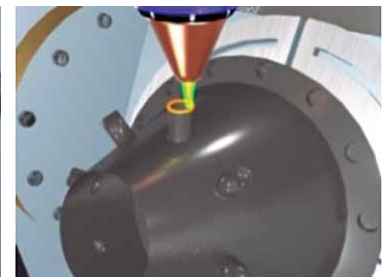

Additive manufacturing

FANUC *i*HMI

30i-B, 31i-B, 31i-B5, 32i-B Only

FANUC *i*HMI supports all jobs at shop floor consistently, exceeding a limit of conventional CNC operation. In FANUC *i*HMI, the functions required for each of processes, "plan", "machining", and "improvement", performed in a shop floor are put into an integration screen called home. The functions can operate in cooperation with one another.

FANUC *i*HMI provides not only functions related to display and other operations, but also performance as a thin client including a function which uploads various types of information related to machining to the upper-level system in the network and a function which shares information accumulated in the database in the upper-level system. FANUC *i*HMI will act as a platform which plays core roles in the IoT introduced for machine tools.

Tool manager

- Tool manager consolidates tool information required by a shop floor.
- This function reads tool data provided by tool manufacturers. The data can be used for CNC machining and FANUC *i*HMI applications.
- The data corresponds to model numbers, dimensions, and machining conditions in catalog data for management.

Cycle time estimation

- Cycle time estimation strongly supports complex mold machining.
- The difference between the cycle time of actual machining and estimated cycle time is $\pm 5\%$.
- This function estimates the machining time in a short time.

Conversational function for lathes

- The conversational function for lathes allows you to perform programming for lathes easily without considering G codes.
- This function supports milling also for a tilted plane as well as turning machining.
- The function remarkably reduces the programming time by automatic process determination.

CNC operation

- CNC operations are consolidated into the three screens for "programming", "set up", and "machining" to drastically improve operability.
- The operation system along the flow of operations enables easy-to-understand operation.
- The help, troubleshooting, and other functions are available to solve problems at a time if you have difficulty.

Data logger

- Data logger periodically collects various types of CNC data.
- The collected data can be used by FANUC *i*HMI applications.
- The data can also be accessed via a network.

Maintenance manager

- Maintenance manager monitors the status of each service part and notifies you of an alarm before the part gets out of order.
- This function supports inspection and replacement with manual display.
- In addition to CNC parts, the function can also monitor mechanical parts.

SERVO Viewer

- SERVO viewer displays waveforms indicating machine operation according to the position of each feed axis, spindle torque, and others.
- This function can also observe PMC signals and sequence numbers simultaneously.
- The function can be used to reduce the cycle time and improve cutting conditions.



HOME screen

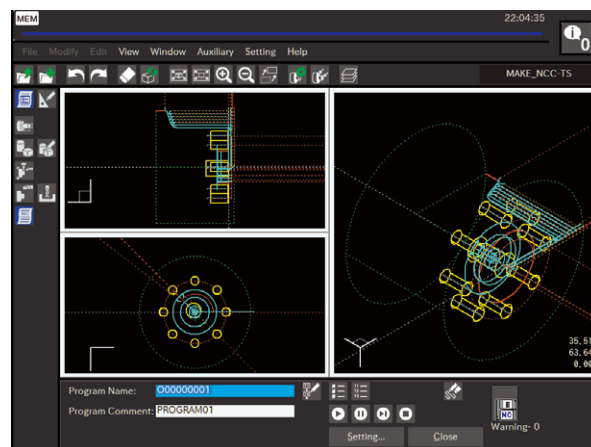

Conversational screen for lathes

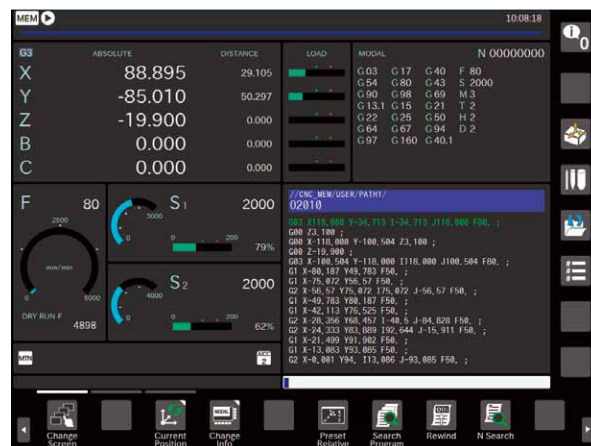

CNC operation screen

High-Speed, Large-Capacity, and Multi-path PMC

High-Speed and Large-Capacity

The built-in PMC function is made much faster and many different types of instructions including floating-point operations are now available. The PMC, which consists of a powerful dedicated processor and latest custom LSI, processes a large sequence of programs at a high speed.

- Program capacity Max. 300,000 steps (Total of all PMC paths)
- Internal relay (R) Max. 60,000 bytes
- Data table (D) Max. 60,000 bytes
- PMC paths Max. 5 paths (Max. 40 ladder programs)

Multi-path PMC

One PMC can execute up to 5 independent ladder programs. Each ladder program has an independent data area, which enables programs to be developed as independent modules. Ladder programs for loader and peripheral control can be created, added and modified separately. Ladder programs can easily be developed and the machine can easily be systematized according to each user's machine configuration. External PLC or other devices for peripheral control becomes unnecessary, which reduces system costs.

Function Block function

- This function is used to call up repeatedly used ladder circuit patterns in blocks.
- By combining multiple Function Blocks, machine tool builders can create complex ladder programs more efficiently, as if assembling components, with fewer steps for ladder program development and fewer ladder diagram drawings for maintenance.
- Many functions, such as PMC axis control and peripheral equipment control, are provided by customizable function blocks as PMC Function Library in FANUC LADDER-III's CD.

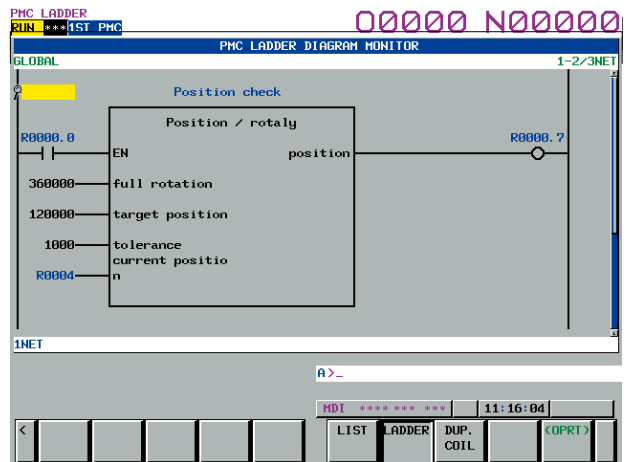
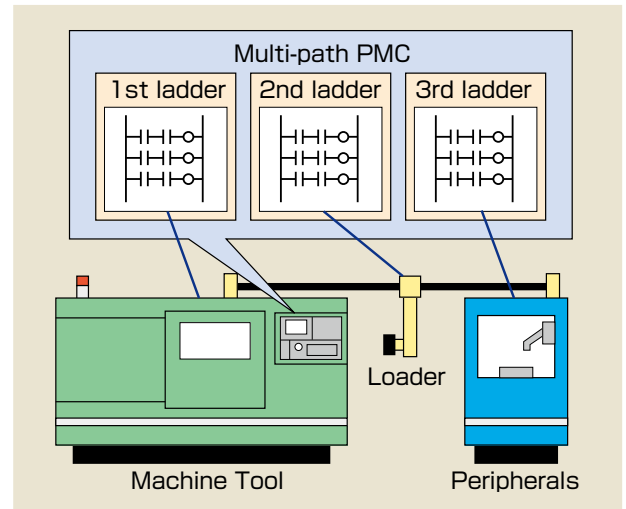

Function Block function

Safety Function

Dual Check Safety + Servo STO

Dual Check Safety is a safety function that conforms to the international safety standard (ISO 13849-1 PL d). This function offers a high level of safety by redundant monitoring, and by providing duplicate paths of breaking power for the servo/spindle amplifier. Safety functions built into the CNC make it easier to conform to the safety standards for machine tools.

- Cost can be reduced by significantly simplifying additional circuits for adherence to the safety standard.
- Two PMC functions have been incorporated into the CNC to duplicate sequence control for safety-related input/output signals.
- Safety-related input/output that is defined by a MTB allows redundant monitoring for controlling peripheral devices.
- By using FANUC I/O Link *i*, 1 channel I/O Link cable can configure safety function.
- The safety machine operator's panel which can make the key signals a safety-related signal is prepared.
- STO (Safe Torque Off function) is equipped in the servo amplifier. Power lines for the motor can be shut off without using the electro-magnetic conductor.

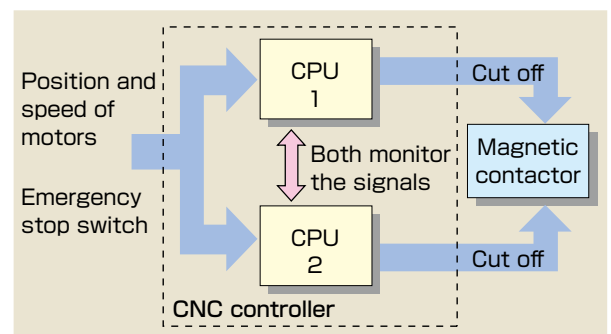

Many Customizable Functions

Ease of Use

Customizable functions are available, which allow machine tool builders to customize their own machine tools

<ul style="list-style-type: none"> • Customizing operation screens • Make the machine tool intelligent by using PC technology 		<p>C Language Executor / FANUC PICTURE</p> <p>PC function with Windows® OS</p>
---	---	--

C Language Executor

Machine tool builders can create their own operation screens, which enables unique CNC display and operation.

- C language is used for programming.
- Multi window display enables creation of pop-up menus.
- Operation screens using the touch panel can be created.
- In addition to standard ANSI functions, many functions are available for CNCs and PMCs.
- High-level tasks to which high execution priority is assigned can monitor signal and position information.

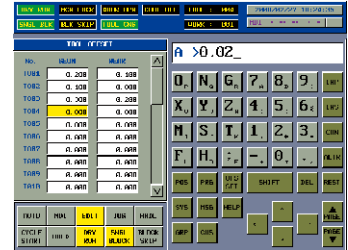

FANUC PICTURE

FANUC PICTURE enables you to create a machine operation screen only by pasting screen components such as buttons and lamps on the PC without programming, for example, with C language.

- You can create a screen available on a display unit with or without a touch panel.
- Easy-to-use interface unique to FANUC

You can also create a screen available on FANUC PANEL *iH*/iH Pro that can effectively use the performance of the display unit.

- You can display the font for each language of any desired size.
- You can display buttons, lamps, and high precision images in full color.



PC function with Windows® OS

Ease of Use

The best combination between a CNC and PC is realized by transferring bulk data via an original high-speed interface. Unique dedicated applications can be achieved easily using a PC, and the machine tools can meet special needs for machine tool customers. PC functions bring a lot of enhancement through up-to-date computer and information technology for intelligent machine tools.

PC functions are maintained long-term by FANUC worldwide service network.

FANUC PANEL *iH* Pro 30i-B, 31i-B, 31i-B5, 32i-B only

FANUC PANEL *iH* Pro is a display unit built-in PC functions suitable for high-end FANUC *iH*MI applications. PANEL *iH* Pro can be connected to a stand-alone CNC to implement sophisticated PC functions supporting Windows® Embedded Standard. Supports the use of commercially available Windows applications.

Features:

Various commercial applications and hardware components are available. Requests from individual customers can flexibly be satisfied.

Application:

Best fit for flexibility with computer applications, such as tool file management by using database software

OS:

Windows® Embedded Standard 7



FANUC PANEL *iH* Pro (15" LCD type)

FANUC PANEL *iH* 30i-B, 31i-B, 31i-B5, 32i-B only

FANUC PANEL *iH* is a standard display unit for FANUC *iH*MI application execution. It supports Windows® Embedded Compact 7, a compact operating system for embedded use, and is best for embedding applications using an HMI unique to a machine tool builder and/or OS real-time property.

Features:

- The use of a highly safe file system (TexFAT) ensures high reliability.
- Windows® Embedded Compact 7 is used.
- TexFAT: Transaction-safe extended FAT

Application:

Best fit for applications dedicated to a machine tool builder such as a machine operator's panel, simple conversational system, and production monitoring and management

OS:

Windows® Embedded Compact 7



FANUC PANEL *iH* (15" LCD type)

Network Support Functions

Ease of Use

With plenty of network functions, you can construct an optimum system for machine tools

Ethernet / Industrial Ethernet / Field network

You can use embedded Ethernet provided as standard and Fast Ethernet with a communication dedicated processor for NC program transfer and remote maintenance.

Various types of industrial Ethernet and field networks are supported to enable various types of peripheral devices to be connected for controlling peripheral devices such as waterproof I/O devices and collecting sensor information.

Supporting industrial Ethernet/field network

- FL-net
- EtherNet/IP (master/slave)
- PROFINET (master/slave)
- PROFIBUS-DP (master/slave)
- DeviceNet (master/slave)
- CC-Link (slave)
- Modbus/TCP (slave)

Via a multi-sensor I/O unit or other devices, information of impact, temperature, and other sensors can also be read.

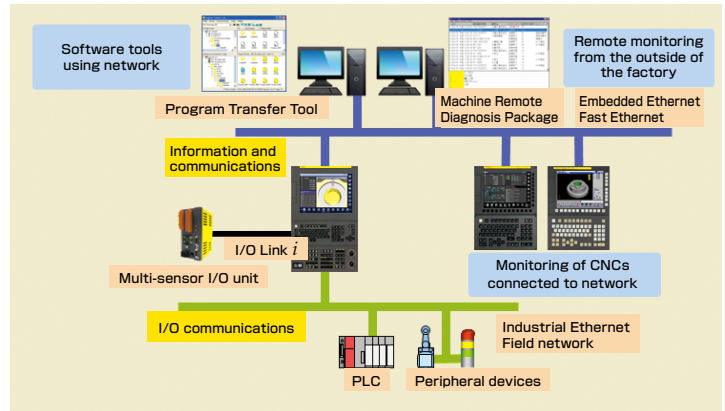

FANUC MT-LINK i (Operation Management software)

MT-LINK i is a software product that can collect, manage, and help visualize various information of machines connected via Ethernet. You can collect not only information of machine tools with FANUC CNCs, but also information of FANUC robot controllers, OPC-compatible PLCs, MTCconnect-compatible machine tools, and more. Also, using an Ethernet I/O converter makes it possible to collect the data of existing devices not equipped with Ethernet I/F.

It enables you to monitor the operation status of machines and manage operation records based on the collected data. Analyzing this data allows you to understand the operational status of machine tools in a factory and contributes to minimizing downtime. There is also a function that transfers machining programs, allowing you to centrally manage the machining programs installed on machine tools in a factory.

Furthermore, linking to the SERVO Viewer makes it possible to schedule the collection of servo data with high-speed (1 ms) sampling of multiple machine tools, and to use this data to carry out preventative maintenance against aging, etc.

The collected data including operation results can be read from a third-party upper host system such as MES (Manufacturing Execution System) and user applications.

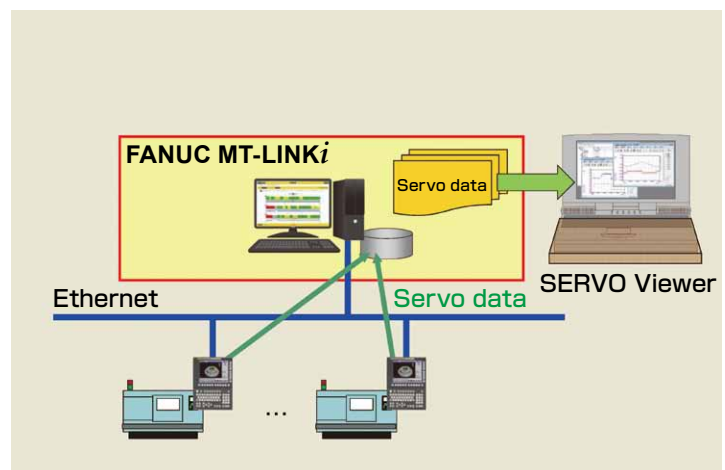
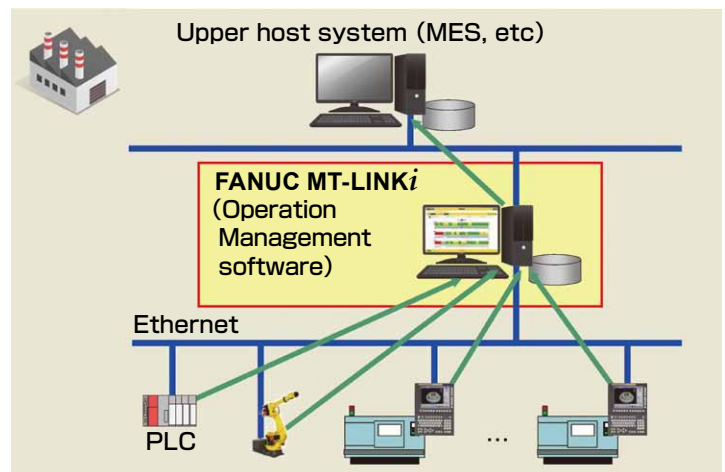

Functions for minimizing downtime

Preventive maintenance

Leakage Detection Function

Insulation deterioration sometimes causes machine to stop due to cutting fluid infiltrating the motor, especially in a severe machining environment.

The leakage detection function built-in amplifier automatically measures insulation resistance of the motor, and detects insulation deterioration when it comes to an abnormal level, this function contributes to preventive maintenance.

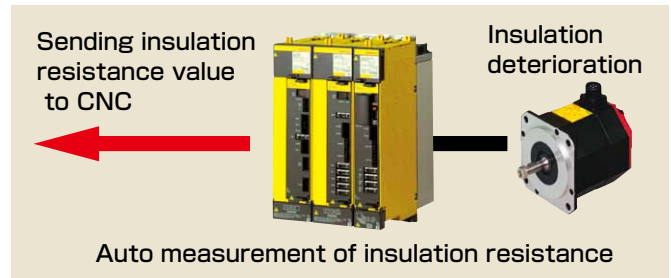

Cooling fan Warning Function

By monitoring a decrease in the rotational speed of each cooling fan motor of the CNC and the servo amplifier, signs of fan abnormalities can be detected.

This function enables preventive maintenance.

Fans are stored in a cartridge and can be replaced quite easily, so maintainability is enhanced.

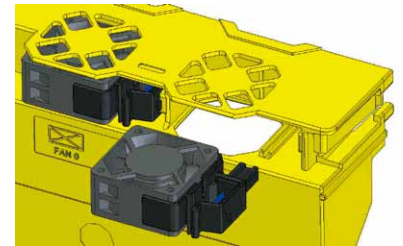

Failure Part Detection

Trouble Diagnostic Function

If a power failure or disconnection of the communication cable happened on the I/O modules and servo amplifiers, it would be detected from a warning alarm from detection functions embedded in the I/O Link *i* and FSSB. It can specify at which point the failure happens. In addition to that, I/O link *i* can detect the ground fault of each DO.

The trouble-shooting function enables you to see diagnosis information helpful in determining the status when an alarm occurs on the CNC screen.

- Trouble-shooting guidance screen
- Trouble-shooting monitor screen
- Trouble-shooting graph screen

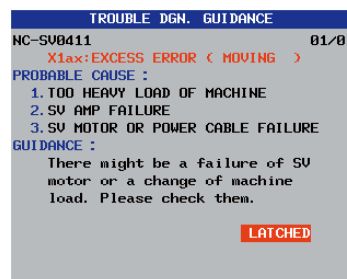
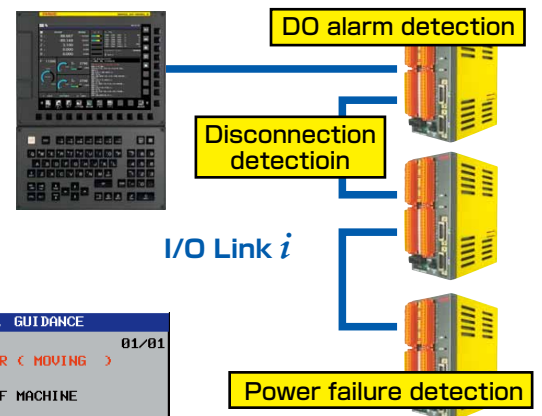

Encoder Communication Check Circuit

When Pulsecoder communication alarm occurs, it is sometimes time consuming to identify the failing part because there are three possibilities: detector, feedback cable, or servo amplifier. It might cause long machine downtime.

Encoder Communication Check Circuit outputs the dummy feedback signal, which makes it easier to identify the failing part quickly.



Protecting Machine at Power Failure

Machine Protection at Power Failure

Damage of workpieces and tools at power failure is prevented where a stable power supply cannot be expected.

- **Gravity-axis drop prevention**
The circuit incorporated in the amplifier detects power interruption and quickly activates the gravity axis brake.
- **Stop distance reduction*1)**
Feed axes are decelerated to stop in order to prevent them from crashing in high-speed machine tools.
- **Retract*2)**
Tool is retracted from workpiece keeping synchronization with gear cutting machine.

*1), *2) "Power Failure Backup Module (Hardware)" or "Power Failure Backup Function (Software)" shall be applied.

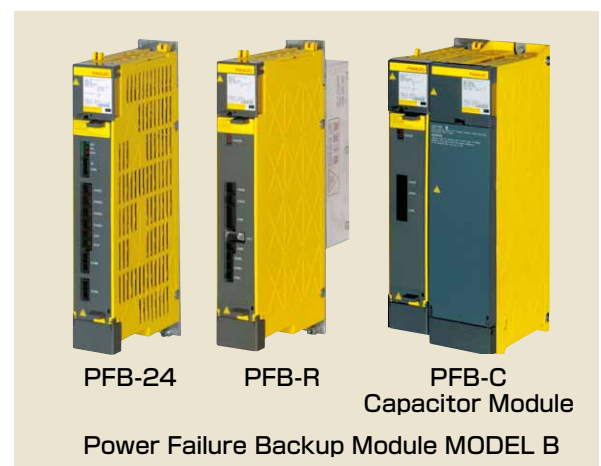

Maintenance and Customer Support

Worldwide Customer Service and Support

FANUC operates customer service and support network worldwide through subsidiaries and affiliates. FANUC provides the highest quality service with the prompt response at any location nearest you.

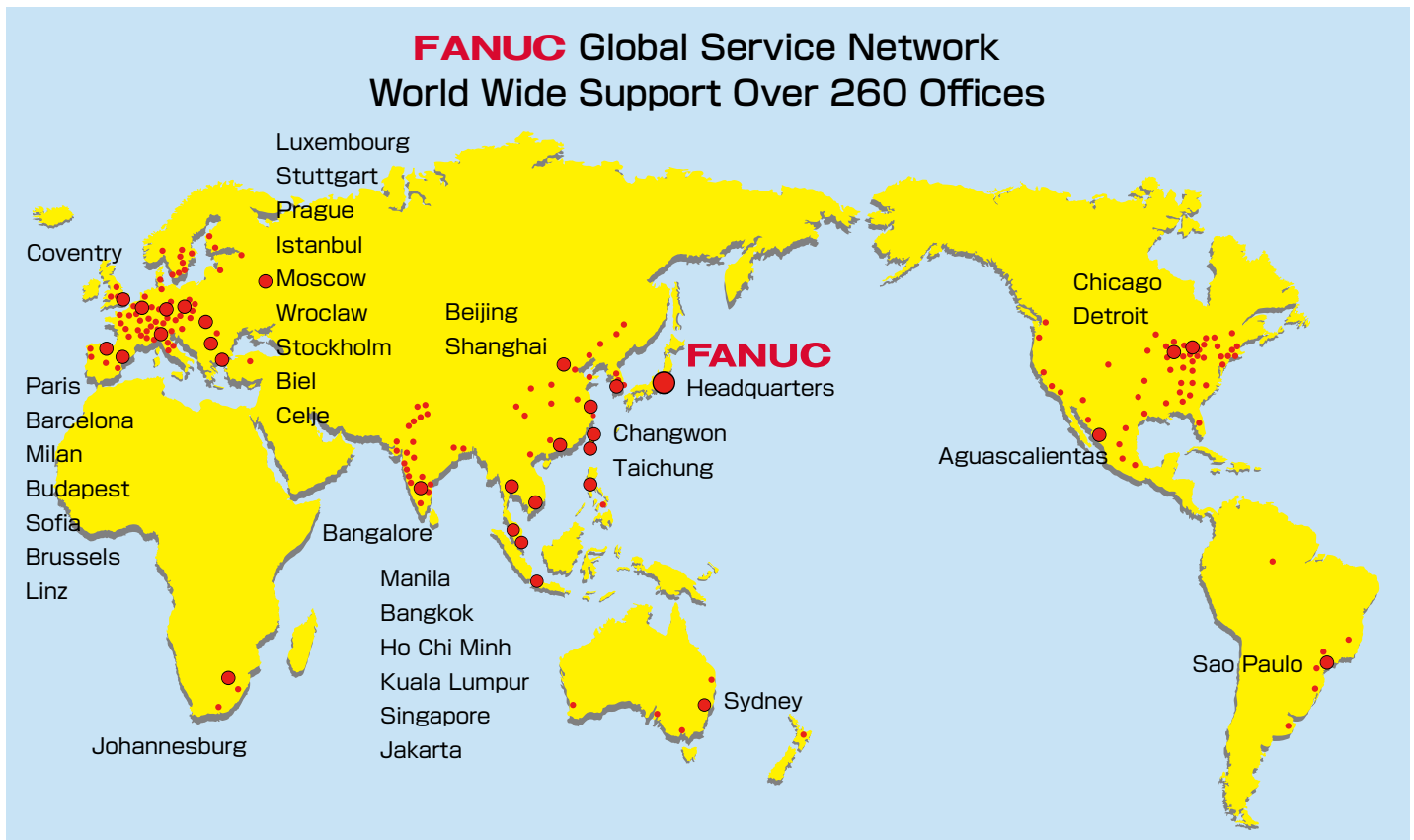

FANUC ACADEMY

FANUC ACADEMY operates versatile training courses to develop skilled engineers effectively in several days.

Inquiries : Oshino-mura, Yamanashi,
Japan 401-0597

Phone : 81-555-84-6030

Fax : 81-555-84-5540



FANUC CORPORATION

•Headquarters Oshino-mura, Yamanashi 401-0597, Japan
Phone: 81-555-84-5555 Fax: 81-555-84-5512 <http://www.fanuc.co.jp>

FANUC America Corporation
1800 Lakewood Boulevard,
Hoffman Estates, Illinois 60192, U.S.A
<http://www.fanucamerica.com/>

FANUC Europe Corporation, S.A.
Zone Industrielle, L-6468 Echternach,
Grand-Duché de Luxembourg
<http://www.fanuc.eu/>

BEIJING-FANUC Mechatronics CO., LTD
No.9 Xinxu Road, Shangdi Information Industry Base,
Haidian District, Beijing CHINA 100085
<http://www.bj-fanuc.com.cn/>

KOREA FANUC CORPORATION
101, Wanam-ro(st), Seongsan-gu, Changwon-si,
Gyeongsangnam-do, 642-290 Republic of Korea
<http://www.fkc.co.kr/>

TAIWAN FANUC CORPORATION
No.10, 16th Road, Taichung Industrial Park, Taichung, Taiwan
<http://www.fanuctaiwan.com.tw/>

FANUC INDIA PRIVATE LIMITED
41-A, Electronics City, Bangalore, 560 100, India
<http://www.fanucindia.com/>

- All specifications are subject to change without notice.
- No part of this catalog may be reproduced in any form.
- The products in this catalog are controlled based on Japan's "Foreign Exchange and Foreign Trade Law". The export of Series 30i-B and 31i-B5 from Japan is subject to an export License by the government of Japan. Other models in this catalog may also be subject to export controls. Further, re-export to another country may be subject to the license of the government of the country from where the product is re-exported. Furthermore, the product may also be controlled by re-export regulations of the United States government. Should you wish to export or re-export these products, please contact FANUC for advice.

© FANUC CORPORATION, 2010

FS30i-B(E)-09, 2018.9, Printed in Japan